

NA5PLUS, NA6PLUS

Universal input digital panel meter with multicolour bargraphs.

NA5PLUSTGU00200E0
DIGITAL BARGRAPH METER 3 COLOUR GREEN 95-
253VAC/DC

- Universal input (programmable)
- Wide voltage, AC/DC control
- Digital and digital bargraph multicolour display



PRODUCT DESCRIPTION

Meters with bargraph are devices ensuring both a high measurement accuracy and very well visualization of the measuring process courses. Very well visualization of the process is possible through using in meters 3 and 7-coloured bargraph built with diodes made in the gallium nitride technology. They can find application in various industrial fields, e.g. food industry, pumping stations and sewage-treatment plants, chemical industry, weather stations, brewing industry and many other fields where they are destined for visualisation of the measured value and evaluation of the monitored manufacturing process change trend. They can also find application in automation systems where programmable controllers are applied.

Please refer to the image below for ordering information.

NASPLUS ordering code:											NA6PLUS ordering code:										
NASPLUS -											NA6PLUS -										
Bargraph colour:											Bargraph colour:										
3-colour (R, G, R+G) T											3-colour(R, G, R+G) T										
7-colour(R, G, B, R+G, R+B, G+B, R+G+B) M											7-colour (R, G, B, R+G, R+B, G+B, R+G+B) M										
Display colour:											Display colour on channels 1 and 2:										
red R											red-red RR										
green G											red-green RG										
custom-made* X											green-red GR										
Input signal:											Input signal:										
universal input U											universal input U										
custom-made* X											custom-made* X										
Analog output:											Analog output:										
lack 0											lack 0										
0/4...20mA 1											0/4...20mA 1										
0...10 V 2											0...10 V 2										
2 x 0/4...20 mA 3											2 x 0/4...20 mA 3										
2 x 0...10 V 4											2 x 0...10 V 4										
1 x 0/4...20 mA, 1 x 0...10 V 5											1 x 0/4...20 mA, 1 x 0...10 V 5										
Additional output:											Additional output:										
lack 0											lack 0										
4 relays 4											4 relays 4										
8 outputs of OC type 8											8 outputs of OC type 8										
Supply voltage:											Supply voltage:										
95...253 V a.c./d.c. 2											95...253 V a.c./d.c. 1										
20...40 V a.c., 20...60 V d.c. 4											20...40 V a.c., 20...60 V d.c. 3										
Kind of terminals:											Kind of terminals:										
screwed plug-in sockets 0											screwed plug-in sockets 0										
Version:											Version:										
standard 00											standard 00										
custom-made* XX											custom-made** XX										
Language:											Language:										
Polish P											Polish P										
English E											English E										
other* X											other* X										
Acceptance tests:											Acceptance tests:										
without extra requirements 0											without extra requirements 0										
with an extra quality inspection certificate 1											with an extra quality inspection certificate 1										
acc. to customer's request X											acc. to customer's request** X										

TECHNICAL DATA

Approvals	EN61010-1
Bargraph colour	3 Colour (R,G, R+G)
Display colour	Green
IP class	IP50
Mounting	Panel mount
Supply voltage	95-253VAC/DC
Weight	0,4 kg

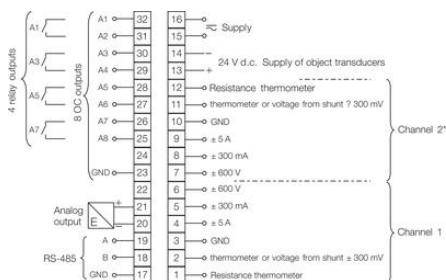

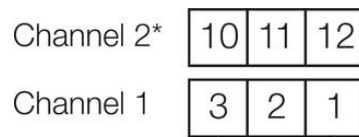

**resistance thermometer
in 2-wire system**

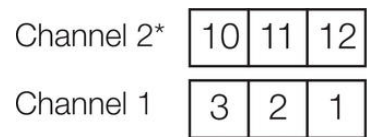

**resistance thermometer
in 3-wire system**

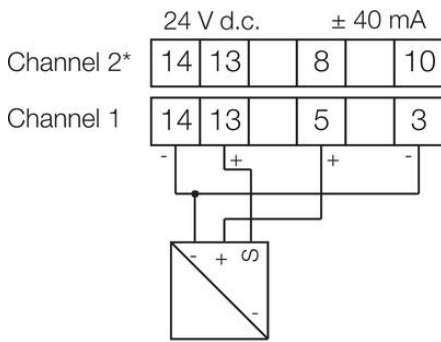

3-wire object transducer

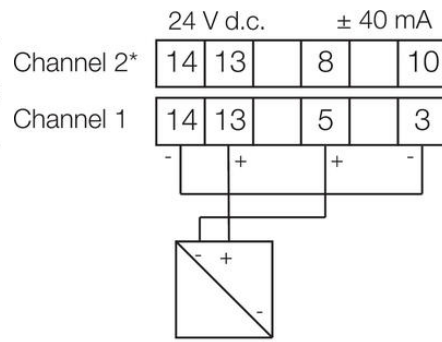

2-wire object transducer

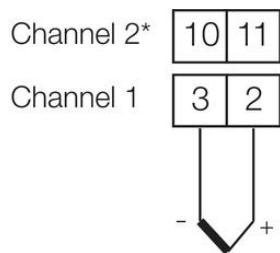
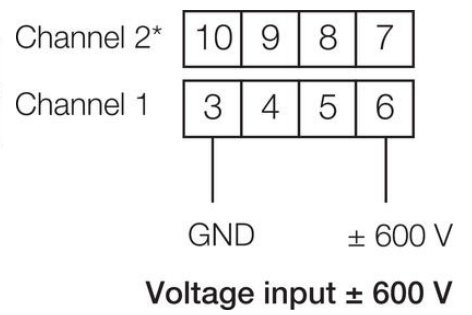

thermocouple or voltage ± 2,5 V