

THK - LBH - TORQUE BALL BUSHING

LBH15

- Compact torque bushing with a straight rectangular shoulder nut.
- High torque capability
- High speed and quiet
- Long maintenance intervals

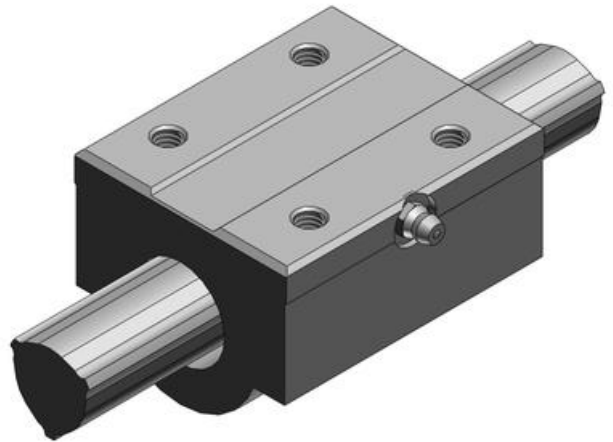

PRODUCT DESCRIPTION

A rigid rectangular spindle nut does not require a housing and can be mounted directly on the machine body.

This results in a compact, very stable linear control system.

The spline shaft has three pairs of precision machined bearing tracks, 120° apart.

The ball lines are held in place and circulate through a ball holder inside the bushing.

This also holds the balls in place if the bushing should be pulled off the shaft.

TECHNICAL DATA

Dynamic load	4,4 kN
Height	29 mm
Length	43 mm
Static load	8,4 kN
Width	34 mm