

TAKEX - F80 FIBRE AMPLIFIER WITH LARGE DIGITAL DISPLAY AND LONG DISTANCES

F80R-PNP
 FIBRE OPTIC AMPLIFIER RED PNP

- Large digital display
- Long distances/fast reaction time
- Teach In



PRODUCT DESCRIPTION

The F80 amplifier has a large, clear display which facilitates the reading of incoming light. On this amplifier, you can choose whether you want long detection distances or a fast reaction time. Reading takes place with Teach In via the green button on the amplifier. You also have the option of manually changing the value on the amplifier to the level at which you want your output signal.

TECHNICAL DATA

Approvals	CE
Electrical connection	Embedded 2m cable
Function	Dark on / Light on
IP class	IP40
Light type	Red LED
Light/dark switching	Yes
Output	PNP
Output current max	0,1 A
Photocell technology	Fiber amplified
Power consumption max	0,032 A
Reaction time	0,19 ms
Temperature operational max	55 °C
Temperature operational min	-25 °C
Voltage dc max	24 V
Voltage dc min	12 V

- Response time
 - Long-distance mode **1.8ms**
 - High-speed mode **190μs**
- Sensing distance (with fibre optic cable FR105BC)
 - Long-distance mode **570mm**
 - High-speed mode **320mm**



Level indication, received light

PNP-output

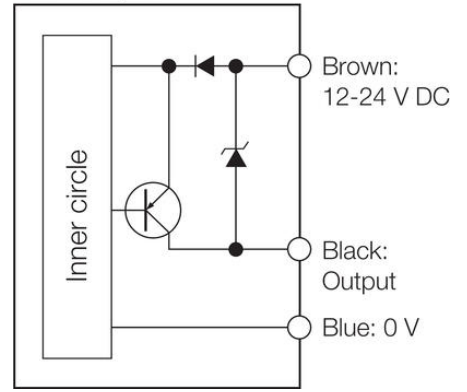

5 seconds

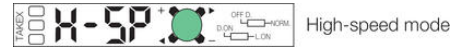
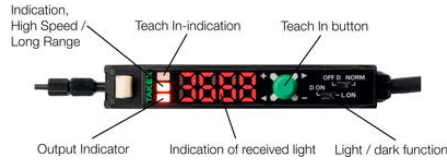
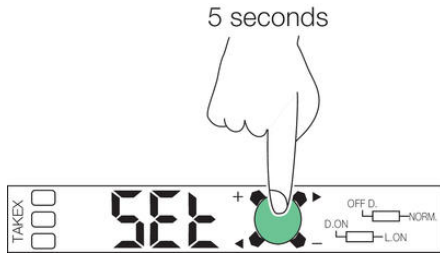

High-speed mode

3 seconds

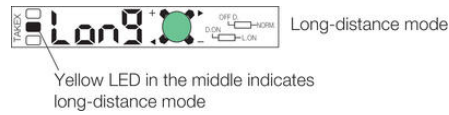
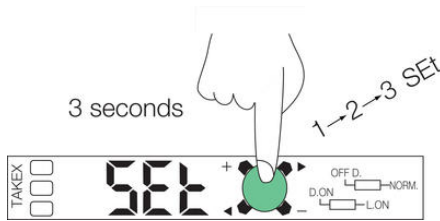

Long-distance mode

Yellow LED in the middle indicates long-distance mode



3 seconds

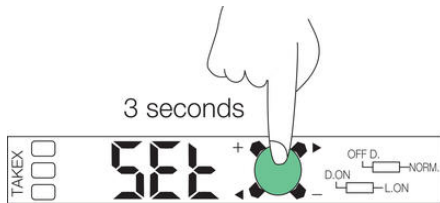

Level indication, received light

