

CROUZET SWITCHES - V3

83161338

V3 MICROSWITCH C/O W3

- Rated data 0.1 A to 20 A/250 V ac
- Operating temperature up to +125 °C
- Compliant with standards EN 61058 and UL 1054
- Four different control arm installation options

**PRODUCT DESCRIPTION****TECHNICAL DATA**

Connection	W3
Contact gap	0,4 mm
Contact type	Changeover (SPDT)
Force of the return movement min	0,2 N
Hysteresis max	0,35 mm
IP class	IP40
Operating force max	0,8 N
Operating power total max	2 N
Overtravel min	1,2 mm
Permissible overvoltage max	20 N
Rated current at 250 V ac	16 A
Sleep max	16,2 mm
Switching point	14,7±0,3 mm
Temperature operational max	125 °C
Temperature operational min	-60 °C
Thermal current at 250 V ac	20 A

W3 for 6.35 mm clips (6.3 x 0.8)

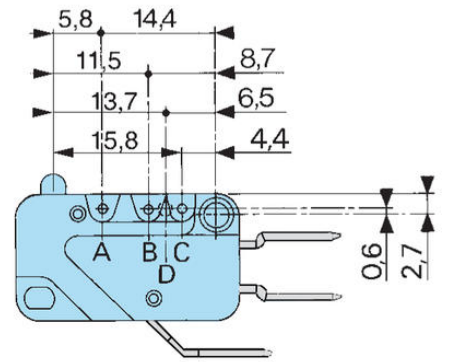
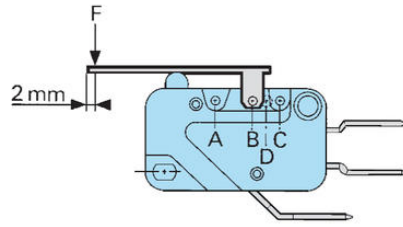
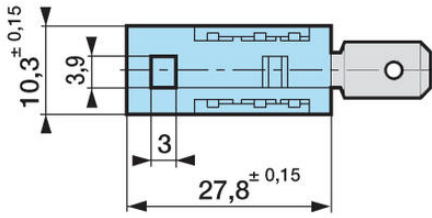
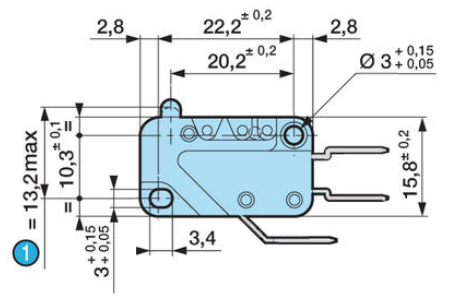
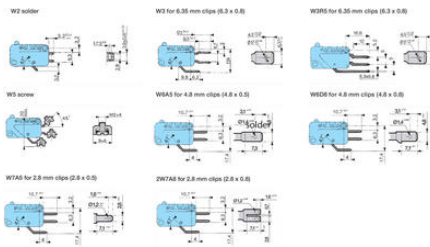
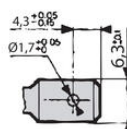
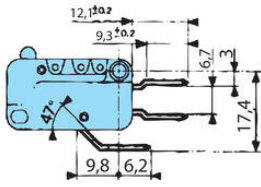

161 F

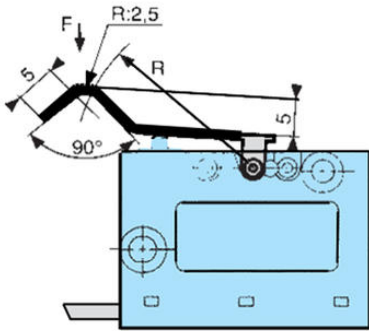

161 G

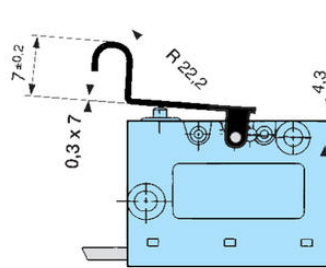

161 A

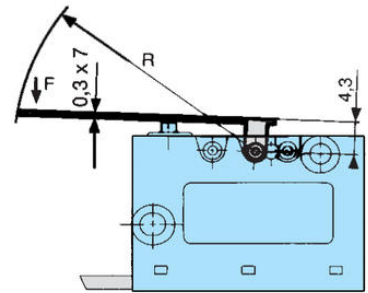

161 E

