

CROUZET - BLDC SQ57 MOTOR WITH INTEGRATED TNi21 DRIVE

80140XXX TNi21
 BLDC motor with Internal drive 77W 12→32Vdc
 4000rpm 184mNm

- 12→32 V dc, 38→145 W, 178→490 mNm, 1250→4000 rpm
- Speed & torque control. Easy use.
- Reduce control panel space & cabling
- Long life (>20,000 hours)
- IP65 as standard



PRODUCT DESCRIPTION

The TNi21 integrated drive is ideal for applications where speed and torque control is required.

The long lifetime of the brushless motor (>20,000 hours with rated load) means it is ideal for continuous or long duty applications.

Having the drive integrated into the motor can also save control panel space, reduce cabling and save set-up time.

3 motor sizes available with the same diameter (57mm x 57mm), just increasing the motor length for more power/torque options.

Pre-set I/O mean that the motor can be used immediately without any complex preliminary set-up. It can be controlled via basic switches or by external PLC.

Motor power and logic connections are via cable output or connector options.

The motors are rated to IP65 dust/water protection class as standard.

Options for adaptation to the standard motor include adding an encoder, holding brake, special output shaft, special connectors, upgraded IP protection & special firmware developed according to your specific application requirements.

* Product datasheets & 3D drawing for 0-10Vdc, cable version attached as an example. Further information for PWM version, brake options & connector version available upon request.

Full documentation & user manuals also available upon request.

TECHNICAL DATA

Diameter	57 mm
Integrated control	TNi21
IP class	IP65
Length	92 mm
Life span	20,000h
Nominal torque	0,2 Nm
Number of pulses per revolution	12
Positioning feedback	Yes
Power	77 W
Shaft diameter	8 mm
Speed options	1900rpm→4000rpm
Supply voltage	12 V DC, 24 V DC

Weight

0,95 kg

Curves

Speed / Torque 80140 TN21 - Current / Torque 80140 TN21

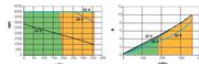

Speed / Torque 80180 TN21 - Current / Torque 80180 TN21

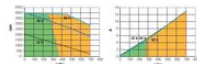

Speed / Torque 80280 TN21 - Current / Torque 80280 TN21

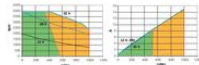

Connections

Connector	Cable	
Power ground	MF	AW213 Blue
Power supply +12 V or +5 V DC	LF	AW216 Orange
Logic ground	GF	AW214 Black (1)
Input 1: On/Off	OP	AW214 Yellow (1)
Input 2: Speed	IP	AW214 Yellow (2)
Output 1: Forward*	OA	AW214 Orange (1)
Output 2: Reverse*	OR	AW214 Brown (1)
Input 3: Stop	SP	AW214 Blue (1)
Output 3: Torque alarm	TA	AW214 Purple (1)

* 12 pins, and 24 for double motor

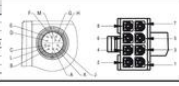

Options

Holding brake 0.5 Nm - 24 V $\overline{\text{DC}}$

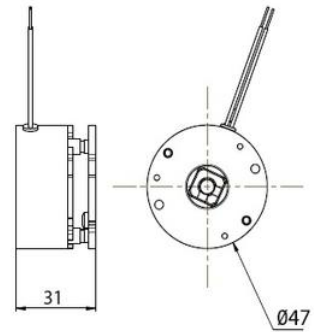

Dimensions (mm)

Cable output versions

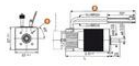

MF connector version - 12 pins

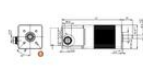

L: 80140: 92 max
L: 80180 / 80280: 112 max
L2: 80140: 120 max
L2: 80180 / 80280: 143 max
More information, see page 16